

MICROWAVE OVEN

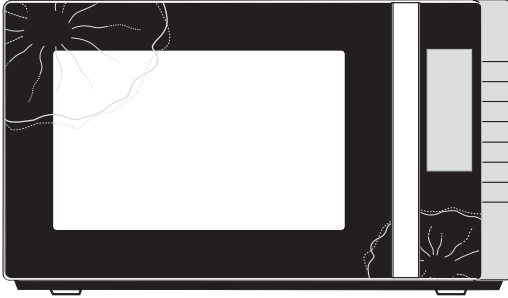

Owner's Manual

MODEL: DW-391HZ

Please read these instructions carefully before installing and operating the oven.

Record in the space below the SERIAL NO. found on the nameplate on your oven and retain this information for future reference.

SERIAL NO.

PRECAUTIONS TO AVOID POSSIBLE EXPOSURE TO EXCESSIVE MICROWAVE ENERGY

- (a) Do not attempt to operate this oven with the door open since this can result in harmful exposure to microwave energy. It is important not to break or tamper with the safety interlocks.
- (b) Do not place any object between the oven front face and the door or allow soil or cleaner residue to accumulate on sealing surfaces.
- (c) **WARNING:** If the door or door seals are damaged, the oven must not be operated until it has been repaired by a competent person.

ADDENDUM

If the apparatus is not maintained in a good state of cleanliness, its surface could be degraded and affect the lifespan of the apparatus and lead to a dangerous situation.

Specifications

Model:	DW-391HZ
Rated Voltage:	230V~50Hz
Rated Input Power(Microwave):	1250W
Rated Output Power(Microwave):	800W
Rated Input Power(Grill):	1000W
Turntable Diameter:	∅ 270mm
External Dimensions:	Approx. 14.5 kg

IMPORTANT SAFETY INSTRUCTIONS

WARNING

To reduce the risk of fire, electric shock, injury to persons or exposure to excessive microwave oven energy when using your appliance, follow basic precautions, including the following:

1. Warning: Liquids and other foods must not be heated in sealed containers since they are liable to explode.
2. Warning: It is hazardous for anyone other than a competent person to remove a cover which gives protection against exposure to microwave energy.
3. Warning: Only allow children to use the oven without supervision when adequate instructions have been given so that the child is able to use the oven in a safe way and understand the hazards of improper use.
4. Warning: When the appliance is operated in the combination mode, children should only use the oven under adult supervision due to the temperatures generated. (only for grill series)
5. Only use utensils suitable for use in microwave ovens.
6. The oven should be cleaned regularly and any food deposits should be removed.
7. Read and follow the specific: "PRECAUTIONS TO AVOID POSSIBLE EXPOSURE TO EXCESSIVE MICROWAVE ENERGY".
8. When heating food in plastic or paper containers, keep an eye on the oven due to the possibility of ignition.
9. If smoke is observed, switch off or unplug the appliance and keep the door closed in order to stifle any flames.
10. Do not overcook food.
11. Do not use the oven cavity for storage purposes. Do not store items, such as bread, cookies, etc. inside the oven.
12. Remove wire twist-ties and metal handles from paper or plastic containers/bags before placing them in the oven.
13. Install or locate this oven only in accordance with the installation instructions provided.
14. Eggs in the shell and whole hard-boiled eggs should not be heated in microwave ovens since they may explode, even after microwave heating has ended.
15. Use this appliance only for its intended uses as described in manual. Do not use corrosive chemicals or vapors in this appliance. This oven is especially designed to heat. It is not designed for industrial or laboratory use.
16. If the supply cord is damaged, it must be replaced by the manufacturer, its service agent or similarly qualified persons in order to avoid a hazard.
17. Do not store or use this appliance outdoors.
18. Do not use this oven near water, in a wet basement or near a swimming pool.
19. The temperature of accessible surfaces may be high when the appliance is operating. Keep cord away from heated surface, and do not cover any vents on the oven.
20. Do not let cord hang over edge of table or counter.
21. Failure to maintain the oven in a clean condition could lead to deterioration of the surface that could adversely affect the life of the appliance and possibly result in a hazardous situation.
22. The contents of feeding bottles and baby food jars shall be stirred or shaken and the temperature checked before consumption, in order to avoid burns.
23. Microwave heating of beverages can result in delayed eruptive boiling, therefore take care when handling the container.
24. The appliance is not intended for use by persons (including children) with reduced physical, sensory or mental capabilities, or lack of experience and knowledge, unless they have been given supervision or instruction concerning use of the appliance by a person responsible for their safety.
25. Children should be supervised to ensure that they do not play with the appliance.
26. The microwave oven shall not be placed in a cabinet unless it has been tested in a cabinet.

27. The appliances are not intended to be operated by means of an external timer or separate remote-control system.
28. The door or the outer surface may get hot when the appliance is operating.
29. The rear surface of appliance shall be placed against a wall.

To Reduce the Risk of Injury to Persons Grounding Installation

DANGER

Electric Shock Hazard

Touching some of the internal components can cause serious personal injury or death. Do not disassemble this appliance.

This appliance must be grounded. In the event of an electrical short circuit, grounding reduces the risk of electric shock by providing an escape wire for the electric current. This appliance is equipped with a cord having a grounding wire with a grounding plug. The plug must be plugged into an outlet that is properly installed and grounded.

WARNING

Electric Shock Hazard

Improper use of the grounding can result in electric shock. Do not plug into an outlet until appliance is properly installed and grounded.

Consult a qualified electrician or serviceman if the grounding instructions are not completely understood or if doubt exists as to whether the appliance is properly grounded. If it is necessary to use an extension cord, use only a 3-wire extension cord.

CLEANING

Be sure to unplug the appliance from the power supply.

1. Clean the inside of the oven after using with a slightly damp cloth.
2. Clean the accessories in the usual way in soapy water.
3. The door frame and seal and neighbouring parts must be cleaned carefully with a damp cloth when they are dirty.

Two-round-pin plug

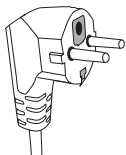

1. A short power-supply cord is provided to reduce the risks resulting from becoming entangled in or tripping over a longer cord.
2. If a long cord set or extension cord is used:
 - 1) The marked electrical rating of the cord set or extension cord should be at least as great as the electrical rating of the appliance.
 - 2) The extension cord must be a grounding-type 3-wire cord.
 - 3) The long cord should be arranged so that it will not drape over the counter top or tabletop where it can be pulled on by children or tripped over unintentionally.

UTENSILS

See the instructions on "Materials you can use in microwave oven or to be avoided in microwave oven."

There may be certain non-metallic utensils that are not safe to use for microwaving. If in doubt, you can test the utensil in question following the procedure below.

CAUTION

Personal Injury Hazard

It is hazardous for anyone other than a competent person to carry out any service or repair operation that involves the removal of a cover which gives protection against exposure to microwave energy.

Utensil Test:

1. Fill a microwave-safe container with 1 cup of cold water (250ml) along with the utensil in question.
2. Cook on maximum power for 1 minute.
3. Carefully feel the utensil. If the empty utensil is warm, do not use it for microwave cooking.
4. Do not exceed 1 minute cooking time.

Materials you can use in microwave oven

Utensils	Remarks
Aluminum foil	Shielding only. Small smooth pieces can be used to cover thin parts of meat or poultry to prevent overcooking. Arcing can occur if foil is too close to oven walls. The foil should be at least 1 inch (2.5cm) away from oven walls.
Browning dish	Follow manufacturer's instructions. The bottom of browning dish must be at least 3/16 inch (5mm) above the turntable. Incorrect usage may cause the turntable to break.
Dinnerware	Microwave-safe only. Follow manufacturer's instructions. Do not use cracked or chipped dishes.
Glass jars	Always remove lid. Use only to heat food until just warm. Most glass jars are not heat resistant and may break.
Glassware	Heat-resistant oven glassware only. Make sure there is no metallic trim. Do not use cracked or chipped dishes.
Oven cooking bags	Follow manufacturer's instructions. Do not close with metal tie. Make slits to allow steam to escape.
Paper plates and cups	Use for short-term cooking/warming only. Do not leave oven unattended while cooking.
Paper towels	Use to cover food for reheating and absorbing fat. Use with supervision for a short-term cooking only.
Parchment paper	Use as a cover to prevent splattering or a wrap for steaming.
Plastic	Microwave-safe only. Follow the manufacturer's instructions. Should be labeled "Microwave Safe". Some plastic containers soften, as the food inside gets hot. "Boiling bags" and tightly closed plastic bags should be slit, pierced or vented as directed by package.
Plastic wrap	Microwave-safe only. Use to cover food during cooking to retain moisture. Do not allow plastic wrap to touch food.
Thermometers	Microwave-safe only (meat and candy thermometers).
Wax paper	Use as a cover to prevent splattering and retain moisture.

Materials to be avoided in microwave oven

Utensils	Remarks
Aluminum tray	May cause arcing. Transfer food into microwave-safe dish.
Food carton with metal handle	May cause arcing. Transfer food into microwave-safe dish.
Metal or metal-trimmed utensils	Metal shields the food from microwave energy. Metal trim may cause arcing.
Metal twist ties	May cause arcing and could cause a fire in the oven.
Paper bags	May cause a fire in the oven.
Plastic foam	Plastic foam may melt or contaminate the liquid inside when exposed to high temperature.
Wood	Wood will dry out when used in the microwave oven and may split or crack.

SETTING UP YOUR OVEN

Names of Oven Parts and Accessories

Remove the oven and all materials from the carton and oven cavity.

Your oven comes with the following accessories:

Glass tray	1
Turntable ring assembly	1
Instruction Manual	1

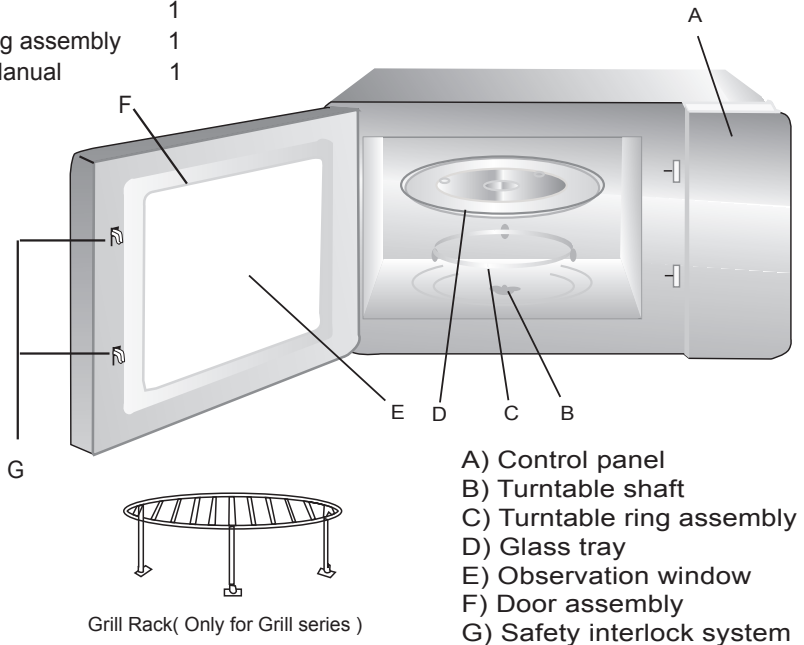

Turntable Installation

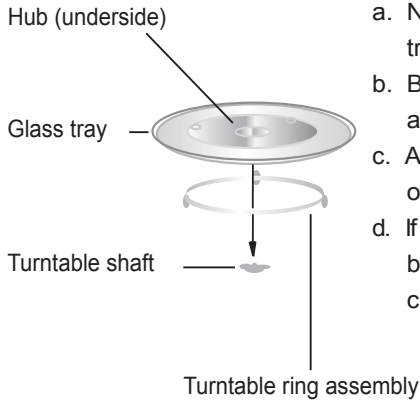

- Never place the glass tray upside down. The glass tray should never be restricted.
- Both glass tray and turntable ring assembly must always be used during cooking.
- All food and containers of food are always placed on the glass tray for cooking.
- If glass tray or turntable ring assembly cracks or breaks, contact your nearest authorized service center.

Countertop Installation

Remove all packing material and accessories. Examine the oven for any damage such as dents or broken door. Do not install if oven is damaged.

Cabinet: Remove any protective film found on the microwave oven cabinet surface. Do not remove the light brown Mica cover that is attached to the oven cavity to protect the magnetron.

Installation

- Select a level surface that provide enough open space for the intake and/or outlet vents.

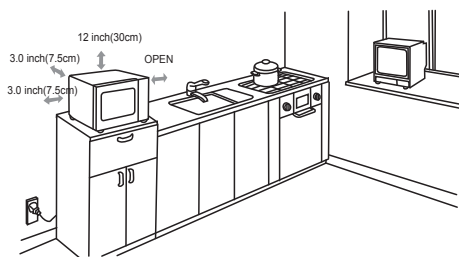

A minimum clearance of 3.0 inches (7.5cm) is required between the oven and any adjacent walls. One side must be open.

- Leave a minimum clearance of 12 inches (30cm) above the oven.
- Do not remove the legs from the bottom of the oven.

- Blocking the intake and/or outlet openings can damage the oven.
- Place the oven as far away from radios and TV as possible. Operation of microwave oven may cause interference to your radio or TV reception.
- Plug your oven into a standard household outlet. Be sure the voltage and the frequency is the same as the voltage and the frequency on the rating label.

WARNING: Do not install oven over a range cooktop or other heat-producing appliance. If installed near or over a heat source, the oven could be damaged and the warranty would be void.





The accessible surface may be hot during operation.



OPERATION INSTRUCTION

This microwave oven uses modern electronic control to adjust cooking parameters to meet your needs better for cooking.

1. Microwave Cooking

- 1) Press the " MICROWAVE " key once, and "P100" will display.
- 2) Press " MICROWAVE" for times or press "  " and "  " to select the microwave power from 100% to 10%. "P100", "P80", "P50", "P30", "P10" will display in order.
- 3) Press "START/+30SEC./CONFIRM " to confirm.
- 4) Press "  " or "  " to adjust the cooking time.
(The time setting should be 0:05- 95:00.)
- 5) Press " START/+30SEC./CONFIRM " to start cooking.





NOTE: the step quantities for the adjustment time of the coding switch are as follow:

0---1 min	:	5 seconds
1---5 min	:	10 seconds
5---10 min	:	30 seconds
10---30 min	:	1 minute
30---95 min	:	5 minutes

Microwave Power Chart





Microwave Power	100%	80%	50%	30%	10%
Display	P100	P80	P50	P30	P10

2. Grill Cooking

- 1) Press the "Grill/Combination" key once, and "G" display.
- 2) Press " Grill/Combination" for times or press "  " or "  " to select the grill power .
- 3) Press "START/+30SEC./CONFIRM " to confirm when the LED display "G".
- 4) Press "  " or "  " to adjust the grill time. (The time setting should be 0:05- 95:00.)
- 5) Press " START/+30SEC./CONFIRM " to start cooking.

Note: If half the grill time passes, the oven sounds twice, and this is normal. In order to have a better effect of grilling food, you should turn the food over, close the door, and then press " START/+30 SEC./CONFIRM" to continue cooking. If no operation, it will continue working.



3. Combination Cooking

- 1) Press the "Grill/Combination " key once, and "G" display.
- 2) Press "Grill/Combination" for times or press "  " or "  " to select the combination power "C-1(55%microwave+45%grill)" and "C-2(36%microwave+64%grill)" will display in order.
- 3) Press "START/+30SEC./CONFIRM " to confirm.
- 4) Press "  " or "  " to adjust the cooking time.
(The time setting should be 0:05- 95:00.)
- 5) Press " START/+30SEC./CONFIRM " to start cooking.

4. Steam Cleaning

- 1) Press the "Steam Clean/ Deodorize " key once, and "10:00" displays.
- 2) Press " START/+30SEC./CONFIRM " to start cleaning.
The buzzer sounds once and the steam works. The microwave power is 100%.
After working for 5 minutes, the fan and turntable stop and the time and power cannot change.



5. Deodorize Cleaning

- 1) Press the "Steam Clean/ Deodorize " key twice, and "dEO" displays.
- 2) Press " START/+30SEC./CONFIRM " to start cleaning. The default time is 10 minutes.
The buzzer sounds once and the steam works. The microwave power is 0%.
Fan works only. You can press "  " or "  " to adjust the time.
The MAX. deodorize time is 60 minutes. And the power cannot be adjusted.

6. Speedy Cooking

- 1) In waiting state, press " START/+30SEC./CONFIRM " key to cook with 100% power level for 30 seconds. Each press on the same key can increase 30 seconds. The maximum cooking time is 95 minutes.
- 2) During the microwave, grill, combination cooking and the defrost by time process, press "START/+30SEC./CONFIRM" to increase the cooking time.
- 3) Under the states of auto menu and defrost by weight, cooking time cannot be increased by pressing "START/+30SEC./CONFIRM".

7. Defrost By Weight







- 1) Press " DEFROST BY Wt." once, the screen will display "dEF1".
- 2) Press "  "or "  " to select the food weight. The range of weight is 100-2000g.
- 3) Press " START/+30SEC./CONFIRM " key to start defrosting.

8. Multi-Stage Cooking







Two stages can be maximumly set. If one stages is defrosting, it should be put in the first stage. The buzzer will ring once after each stage and the next stage will begin.

Note: Auto menu cannot be set as one of the multi-stage.

Example: if you want to defrost the food of 200 grams, then to cook with 80% microwave power for 7 minutes. The steps are as following:

- 1) Press "DEFROST BY Wt. " twice, the LED display "dEF1".
- 2) Press "  "or "  " to adjust the defrost weight of 200g.
- 3) Press "MICROWAVE" once, LED will display "P100".
- 4) Press "  " or "  "to choose microwave power till "P80" display;
- 5) Press "START/+30SEC./CONFIRM" to confirm, LED will display "P80".
- 6) Press "  " or "  " to adjust the cooking time of 7 minutes;
- 7) Press "START/+30SEC./CONFIRM" to start cooking.

9. Auto Menu

- 1) In waiting state, press "  " or "  " to choose the main menu.
On the LED, Appetizer, Sweet Dishes, South Asian Cuisines, Makhni Cuisines, Down Town Cuisines, Memoni Cuisines, Curry and Caal Cuisines or International Cuisines will flash.
- 2) Press "START/+30SEC./CONFIRM " to confirm the main menu you choose;
- 3) Press "  " or "  " to choose the sub menu from A-1 to a-56.
- 4) Press "START/+30SEC./CONFIRM " to confirm the sub menu you choose;
- 5) Press "  "or "  " to choose the food weight.
Now you can press "CALORIE INDICATOR" to check the calorie of the food.
- 6) Press "START/+30SEC./CONFIRM " to start cooking;
- 7) After cooking finish, the buzzer sounds five times. The LED display "0:00".
If the time has been set, current time will be displayed.

10. Lock Function for Children



Lock: In waiting state, press " STOP/CLEAR " for 3 seconds, there will be a long beep denoting entering the children-lock state, the LED will display "  ".

Lock quitting: In locked state, press " STOP/CLEAR " for 3 seconds, there will be a long "beep" denoting that the lock is released.

11. Inquiring Function

- 1) In cooking states of microwave, grill and combination. Press " MICROWAVE " the current power will be displayed for 2-3 seconds.
- 2) During weight setting in auto menu state, press "Calorie Indicator " to check the calorie.

12. Specification

- (1) The buzzer will sound once when you press the ""or"  " key at the beginning.
- (2) "START/+30SEC./CONFIRM" must be pressed to continue cooking if the door is opened during cooking;
- (3) Once the cooking programme has been set , "START/+30SEC./CONFIRM" is not pressed in 1 minute. The current time will be displayed. The setting will be cancelled.
- (4) The buzzer sounds once by efficient press, inefficient press will be no response.

Trouble shooting

Normal	
Microwave oven interfering TV reception	Radio and TV reception may be interfered when microwave oven operating. It is similar to the interference of small electrical appliances, like mixer, vacuum cleaner, and electric fan. It is normal.
Dim oven light	In low power microwave cooking, oven light may become dim. It is normal.
Steam accumulating on door, hot air out of vents	In cooking, steam may come out of food. Most will get out from vents. But some may accumulate on cool place like oven door. It is normal.
Oven started accidentally with no food in.	It is forbidden to run the unit without any food inside. It is very dangerous.

Trouble	Possible Cause	Remedy
Oven can not be started.	(1) Power cord not plugged in tightly.	Unplug. Then plug again after 10 seconds.
	(2) Fuse blowing or circuit breaker works.	Replace fuse or reset circuit breaker (repaired by professional personnel of our company)
	(3) Trouble with outlet.	Test outlet with other electrical appliances.
Oven does not heat.	(4) Door not closed well.	Close door well.
Glass turntable makes noise when microwave oven operates	(5) Dirty roller rest and oven bottom.	Refer to "Maintenance of Microwave" to clean dirty parts.



According to Waste of Electrical and Electronic Equipment (WEEE) directive, WEEE should be separately collected and treated. If at any time in future you need to dispose of this product please do NOT dispose of this product with household waste. Please send this product to WEEE collecting points where available.